

# МОЩНЫЙ СВЕТОДИОД ARPL-1W-EPL UV365

## FEATURES

- Low voltage operation.
- Instant light.
- Long operating life.

## APPLICATIONS

- The UV curing (ink, glue, manicure).
- Industrial application (exposure, bonding).
- Disinfection, sterilization (water treatment, clean air, food preservation).
- Anti-counterfeiting recognition (barcode, criminal identification).

## PACKAGE DIMENSIONS

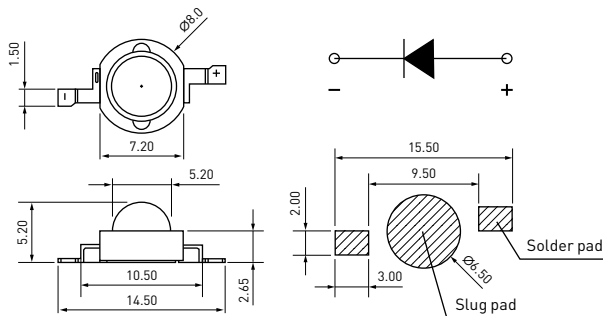

Note: all dimensions in mm tolerance is  $\pm 0.1$ mm unless otherwise noted.



## PARAMETERS

### ABSOLUTE MAXIMUM RATINGS (AT $T_A = +25^\circ\text{C}$ )

Parameter	Symbol	Rating	Unit
DC Forward Current	$I_F$	<b>700</b>	<b>mA</b>
Peak Pulse Current*	$I_{FP}$	<b>1000</b>	<b>mA</b>
Reverse Voltage	$V_R$	<b>5</b>	<b>V</b>
Reverse Current	$I_R$	<b>10</b>	<b><math>\mu\text{A}</math></b>
Power Dissipation	$P_D$	<b>3</b>	<b>W</b>
Operating Temperature Range	$T_{OPR}$	<b>-40... +85</b>	<b><math>^\circ\text{C}</math></b>
Storage Temperature Range	$T_{STG}$	<b>-40... +100</b>	<b><math>^\circ\text{C}</math></b>
LED Junction Temperature	$T_J$	<b>120</b>	<b><math>^\circ\text{C}</math></b>

#### Notes:

1. 1/10 Duty cycle, 0.1ms pulse width.
2. Care is to be taken that power dissipation does not exceed the absolute maximum rating of the product.
3. When the LEDs are in operation the maximum current should be decided after measuring the package temperature, junction temperature should not exceed the maximum rate.

## ELECTRO-OPTICAL CHARACTERISTICS

(AT  $T_A = +25^\circ\text{C}$ )

Parameter	Symbol	Min.	Avg.	Max.	Units	Conditions
Forward Voltage	$V_F$	<b>3.2</b>	—	<b>3.8</b>	<b>V</b>	$I_F=350\text{mA}$
Thermal Resistance Junction To Board	$R\theta_{J-B}$	—	<b>6.5</b>	—	<b><math>^\circ\text{C/W}</math></b>	$I_F=350\text{mA}$
Radiant Flux	$\Phi_e$	<b>500</b>	—	<b>600</b>	<b>mW</b>	$I_F=350\text{mA}$
Peak Wavelength	$\lambda_p$	<b>360</b>	—	<b>370</b>	<b>nm</b>	$I_F=350\text{mA}$
Temperature Coefficient of Forward Voltage	$\Delta V_F/\Delta T$	—	<b>-2</b>	—	<b>mV/<math>^\circ\text{C}</math></b>	$I_F=350\text{mA}$
Reverse Current	$I_R$	—	—	<b>10</b>	<b><math>\mu\text{A}</math></b>	$V_R=5\text{V}$
Viewing Angle	$2\theta_{1/2}$	—	<b>120</b>	—	<b>Deg</b>	$I_F=350\text{mA}$

#### Notes:

1. The above forward voltage measurement allowance tolerance is  $\pm 0.1\text{V}$ .
2. The above radiant flux measurement allowance tolerance is  $\pm 10\%$ .
3. The above color coordinates measurement allowance tolerance is  $\pm 0.003$ .
4.  $2\theta_{1/2}$  is the angle from optical centerline where the luminous intensity is  $1/2$  the optical centerline value.

# TYPICAL ELECTRO-OPTICAL CHARACTERISTICS CURVES

( $T_A = +25\text{ }^\circ\text{C}$ ,  $I_F = 700\text{ mA}$ , Unless Otherwise Noted)

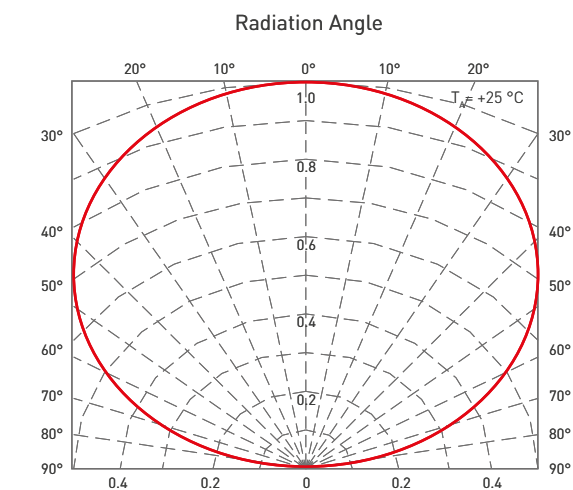
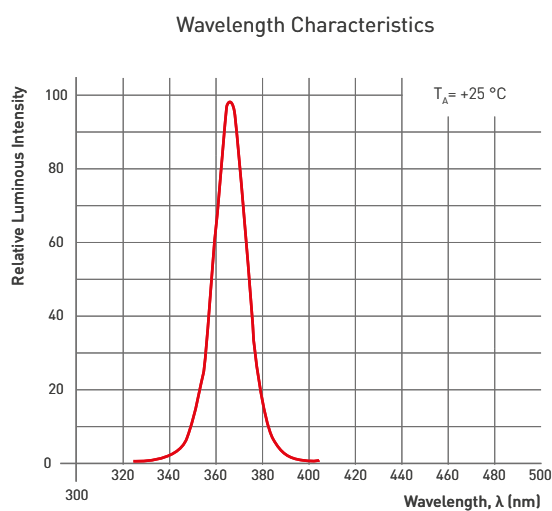
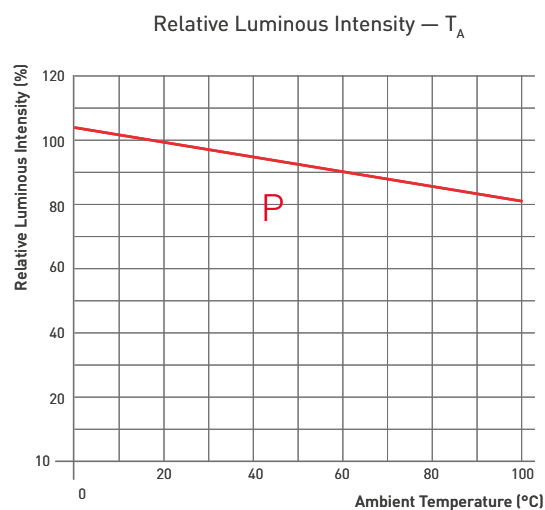
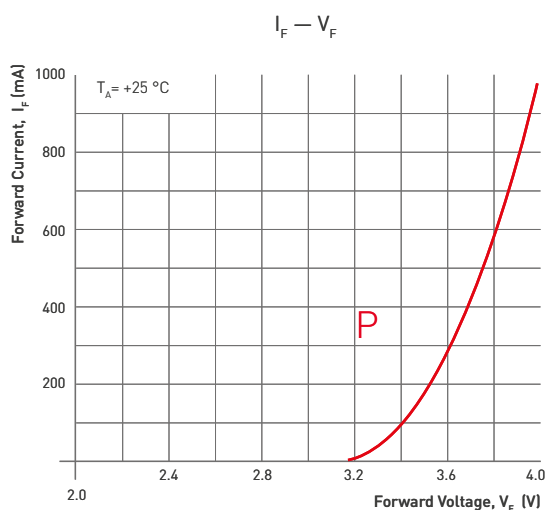
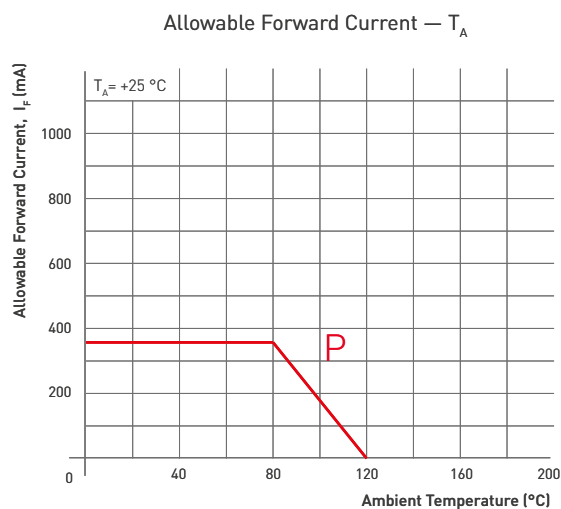
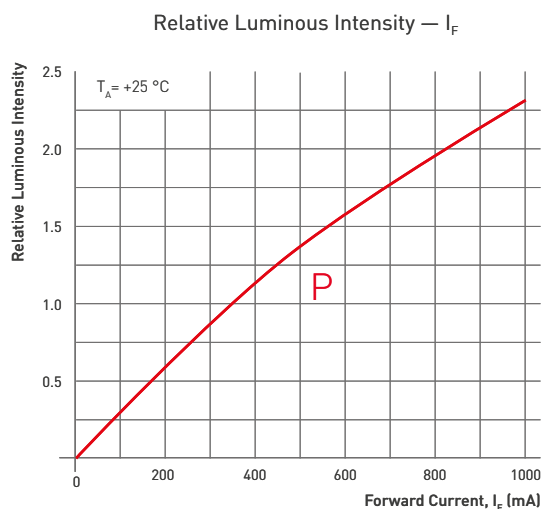

## RELIABILITY TEST STANDARDS

Test Item	REF. Standard	Test condition	Duration	Sample count	Accept
Temperature cycle	JESD22-A104-A	100 ±5 °C... +25 °C 30 min, 5 min, 30 min, 5 min	100 cycles	22	0/22
High temperature storage	JEITA ED-4701 200 201	Ta=100 ±5 °C	1000 hrs	22	0/22
Low temperature storage	JEITA ED-4701 200 202	Ta=-40 ±5 °C	1000 hrs	22	0/22
Humidity heat storage	JIS C 7021 (1977) B-11	Ta=60 °C RH=85%	1000 hrs	22	0/22
Life test	JESD22-A108-A	Ta=25 °C I <sub>F</sub> =700mA	1000 hrs	22	0/22
High humidity heat life test	JESD22-A101	Ta=60 °C RH=85% I <sub>F</sub> =700mA	1000 hrs	22	0/22

## CRITERIA FOR JUDGING DAMAGE

Test Item	Symbol	Test condition	Criteria For Judgement	
			Min	Max
Forward Voltage	V <sub>F</sub>	I <sub>F</sub> =700mA	—	U.S.L*]1.1
Reverse Current	I <sub>R</sub>	V <sub>R</sub> =5V	—	10μA
Luminous Flux	Lm	I <sub>F</sub> =700mA	L.S.L*]0.7	—
Lamp bead lighting test		I <sub>F</sub> =700mA		

U.S.L: Upper standard level.

L.S.L: Lower standard level.

Note:

The above technical data is only the typical value of the product, not as any application conditions and application mode guarantee.

# SMT REFLOW SOLDERING INSTRUCTIONS

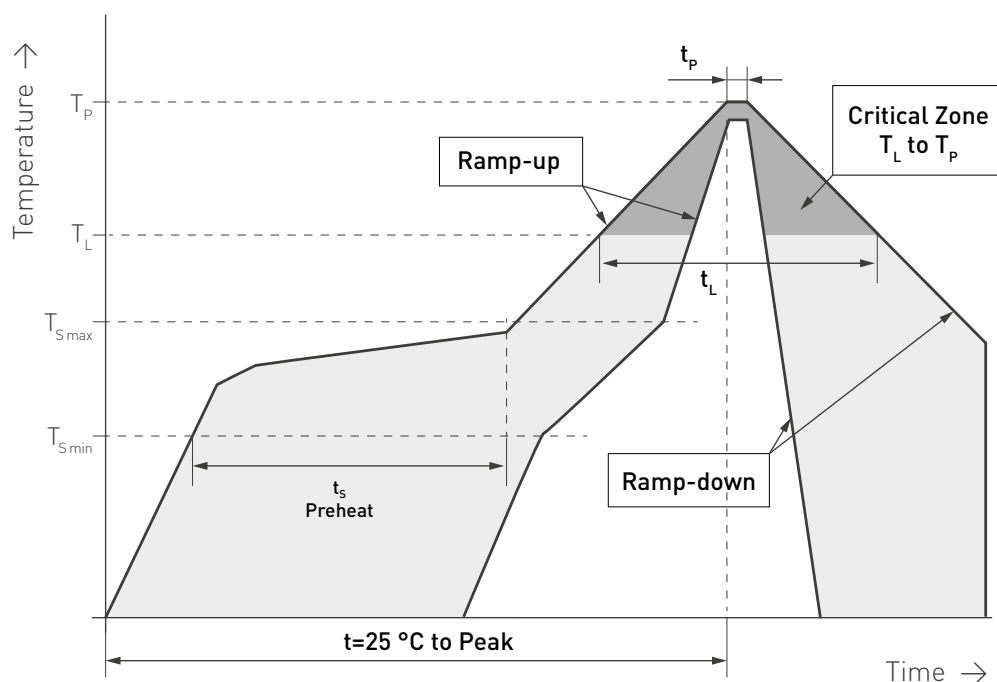

Notes for reflow [if reflow products are needed]

1. Reflow soldering should not be done more than two times. In the case of more than 24 hours passed soldering after first, LEDs will be damaged.
2. When welding, do not press hard on the colloid surface when the material is heated.
3. Scrape the heat-conducting solder paste on the aluminum base plate, stir the solder paste clockwise for 10–15 minutes before scraping the solder paste, and place the aluminum base plate on the solder paste scraping tool. Scrape the solder paste evenly and thickly.
4. Scrape solder paste steel mesh needs to be made into a cross, so as to allow air circulation, avoid solder paste lifting caused by LED poor heat dissipation.
5. Note that the lamp should be installed flat and the two pins of the LED light source should be installed on the welding pad position of the aluminum substrate.
6. Scrape the aluminum base plate of solder paste in 2 hours to install all the light source, light source installed in the aluminum base plate, the operator should self-check whether the light source is installed (can't have reverse, light source bottom suspension) to tilt 45 degrees angle to check each light source.
7. After reflow welding, check whether the light source is in the position of the welding pad, and do not have eccentric phenomenon, or the line will be broken in the second light distribution lens, resulting in open circuit.
8. Rapid cooling is not allowed after reflow soldering.
9. Do not weld on deformed PCB.

## Soldering Iron

1. When hand soldering, keep the temperature of iron below less 300 °C less than 3 seconds.
2. The hand solder should be done only one time.

## Repairing

Repair should not be done after the LEDs have been soldered. When repairing is unavoidable, a double-head soldering iron should be used (as below figure). It should be confirmed in advance whether the characteristics of LEDs will or will not be damaged by repairing.

## Cautions

1. LED packaging is silica gel, so the LED colloidal surface is soft, hard pressure on the colloidal surface will affect the LED reliability, so there should be preventive measures to avoid the strong pressure on the package parts, when the suction nozzle, the pressure on the colloidal surface should be appropriate.
2. Components should not be mounted on warped (non-coplanar) portion of PCB. After soldering, do not warp the circuit board.
3. Do not apply mechanical force or excess vibration during the cooling process to normal temperature after soldering.  
Do not rapidly cool device after soldering.

# PACKING STANDARD

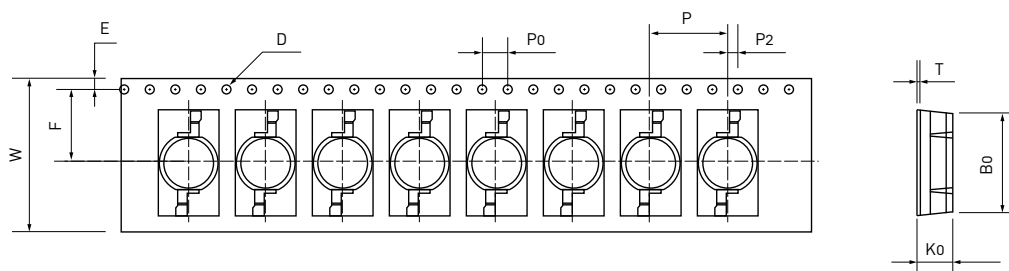

W	24.00	$+0.30$ $-0.30$	P	12.00	$+0.10$ $-0.10$	A0	8.30	$+0.10$ $-0.10$	B0	15.45	$+0.10$ $-0.10$
T	0.40	$+0.05$ $-0.05$	P0	4.00	$+0.10$ $-0.10$	K0	5.80	$+0.10$ $-0.10$	D0	∅1.50	$+0.10$ $-0.10$
E	1.75	$+0.10$ $-0.10$	P2	2.00	$+0.10$ $-0.10$	F	11.50	$+0.10$ $-0.10$			

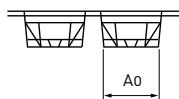

# PRODUCT SPECIFICATION

## Storage/use

1. In order to avoid moisture absorption, it is suggested to store the products in a drying cabinet with desiccant. The storage temperature is 5–30 °C, and the humidity is  $\leq 60\%$  HR.
2. After storage for six months, it is recommended to re-use the spectral separation to prevent changes in photoelectric parameters.
3. It is recommended to dry products that have been sealed and stored for more than six months before use. The drying condition is  $65 \pm 5$  °C for 10 hours.
4. The product shall be used within 24 hours after opening, otherwise it shall be baked at 65 °C for 4–6 hours before reflow welding.
5. Do not press the gel surface with any sharp object (such as tweezers). Do not leave fingerprints on the surface of the colloid. The positive normal pressure of the colloid should be less than 2 newtons and the number of press should be less than 3 times. The lateral pressure of the lens body is less than 1.5 newtons and the number of press is less than 3 times. Pick up materials correctly (as shown below).

Products should not be in contact with water, oil or organic solutions.

The operating current value of the product should consider LED junction temperature.

Repackage unused products in moisture-proof bags and store in a dry place.

External dimensions are subject to change without prior notice.

Anti-static requirements: when using products, must wear anti-static ring or anti-static gloves, all equipment, devices, machines must be effectively grounded. This product belongs to electrostatic sensitive device, pay attention to anti-static protection!



**NO**

**OK**

When LED working, push the temperature of PCB board should not exceed 60 °C.

Anti-vulcanization, chlorination, bromination and other treatments.

In the closed, high temperature environment, the lamp may contain sulfur/chlorine/bromine and other substances, these sulfur, chlorine and bromine elements will volatilize into gas and corrosion LED light source. Because the LED seal silica gel has porous structure, and the light source silver plating reaction occurred. After curing reaction of LED light source, the functional area of the product will darken, the luminous flux will gradually decline until it becomes slightly bright, and the color temperature will drift obviously, and the LED light source will eventually fail. It is recommended to conduct sulfur emission test of lamps first to ensure that LED light source works in sulfur-free/chlorine/bromine and other material environment.

When the customer applies LED, it shall refer to the parameters of this specification and the requirements of operating environment. If the LED is used beyond the parameters or standard conditions without verification, our company will not make any quality guarantee.

Other points for attention, please refer to our LED user manual.



**ATTENTION!**  
**ELECTROSTATIC SENSITIVE DEVICES.**  
 OBSERVE PRECAUTIONS FOR HANDLING.